

# ASSEMBLY INSTRUCTION

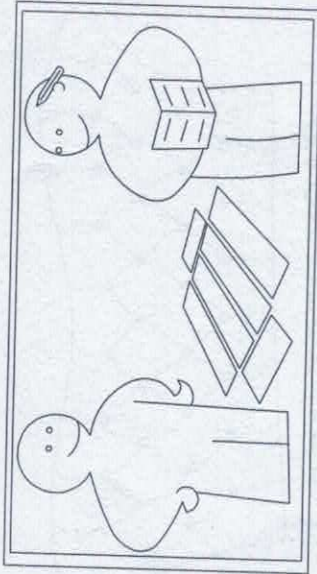

Attention:

Two people are required for assembly and lifting unit.

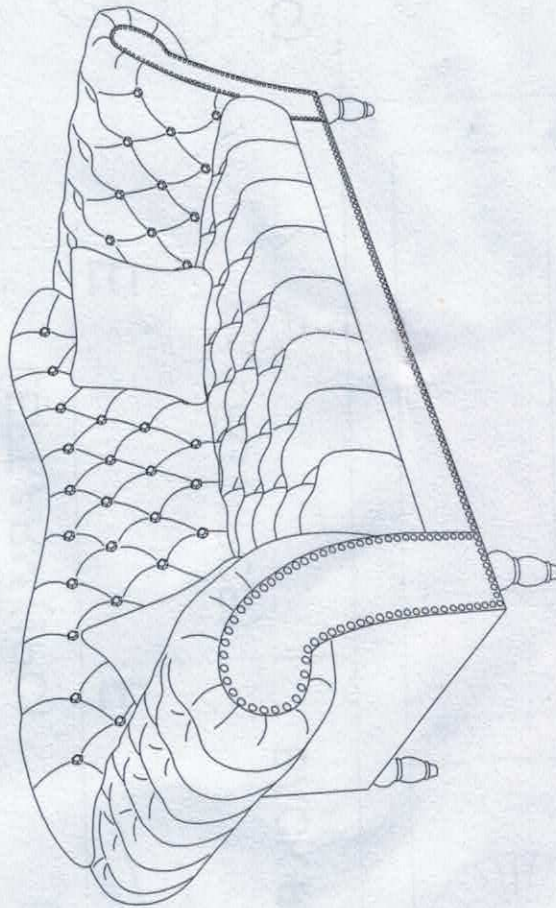

# ASSEMBLY PART

**A**

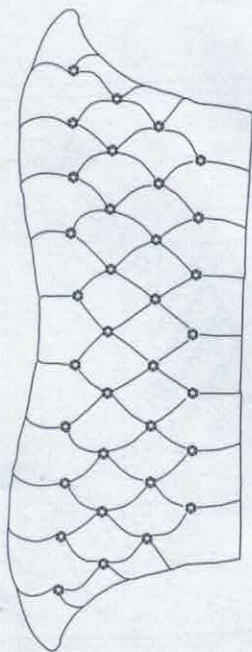

**BACK REST (1PC)**

**C**

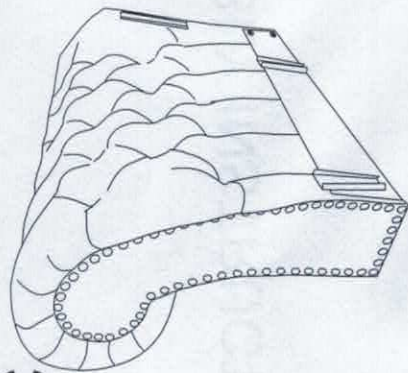

**LEFT ARM (1PC)**

**D**

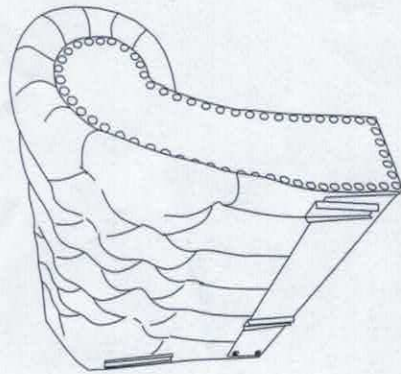

**RIGHT ARM (1PC)**

**B**

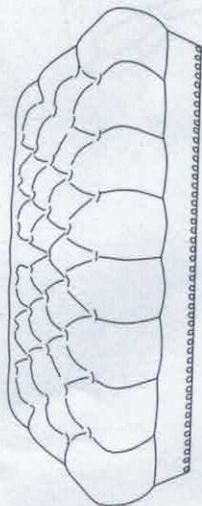

**SEAT FRAME (1PC)**

**E**



**LEG (4PCS)**

**F**

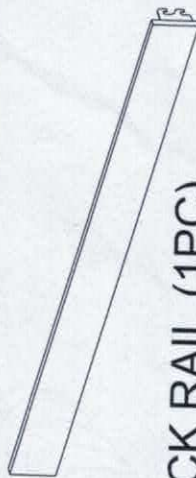

**BACK RAIL (1PC)**

**G**

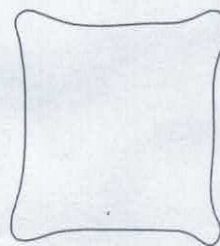

**PILLOW (2PCS)**

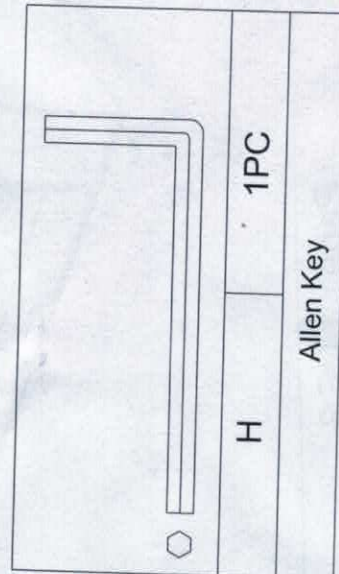

**H** 1PC

Allen Key

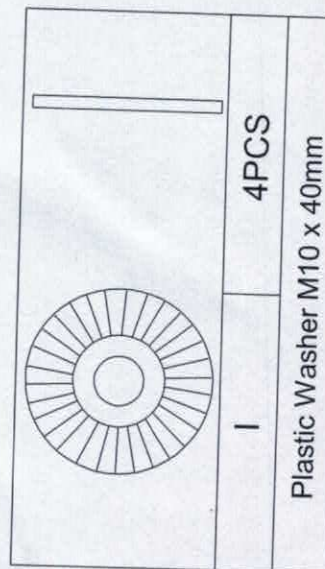

**I** 4PCS

Plastic Washer M10 x 40mm

# BOX OPENING

## Box Opening 1

Please remove all the part from box.

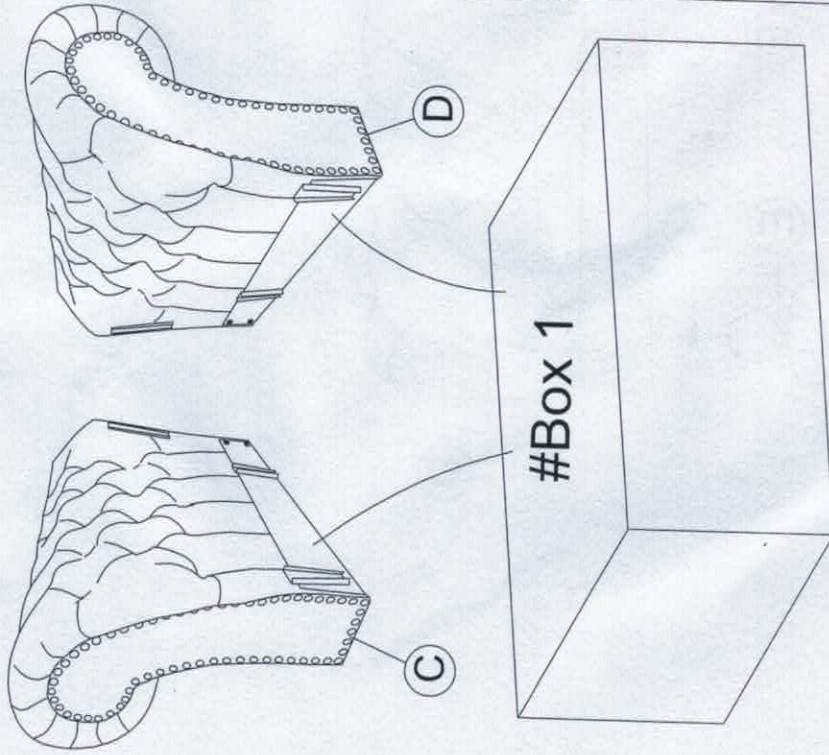

## Box Opening 2

Please remove all the part from box.

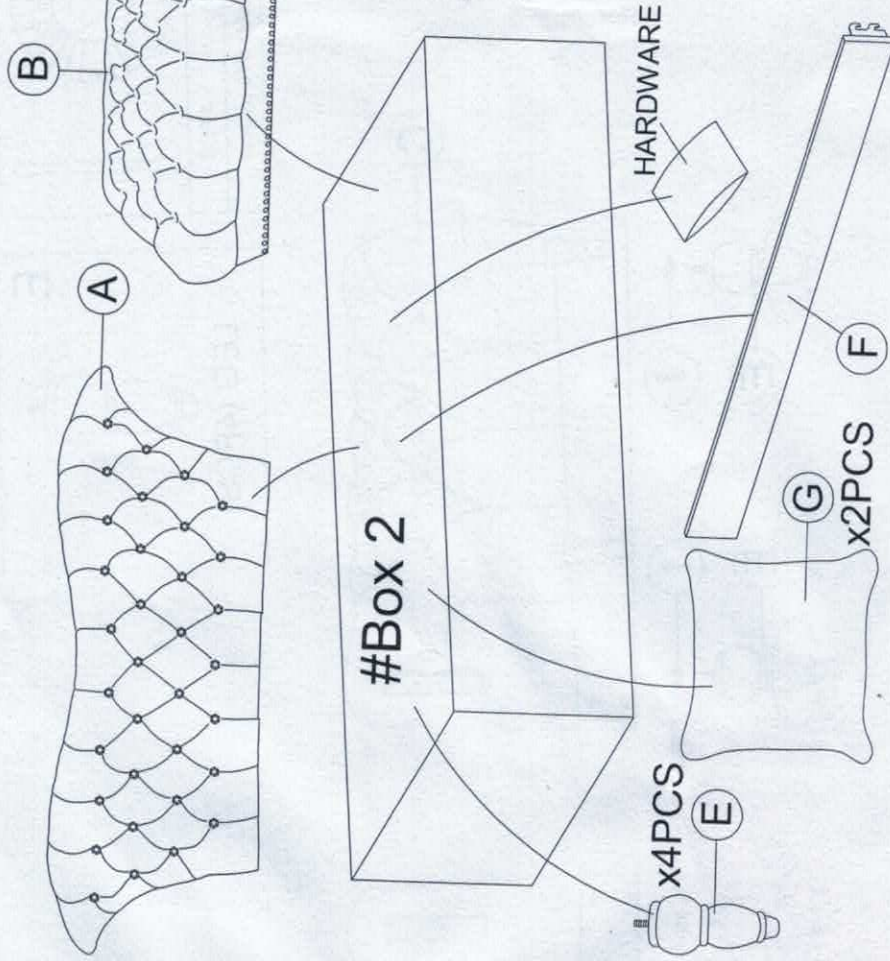

# ASSEMBLY INSTRUCTION

## STEP 1.

Attached the Leg (E) (4pcs) to the Left Arm (C) and Right Arm (D). Legs should be tightened.

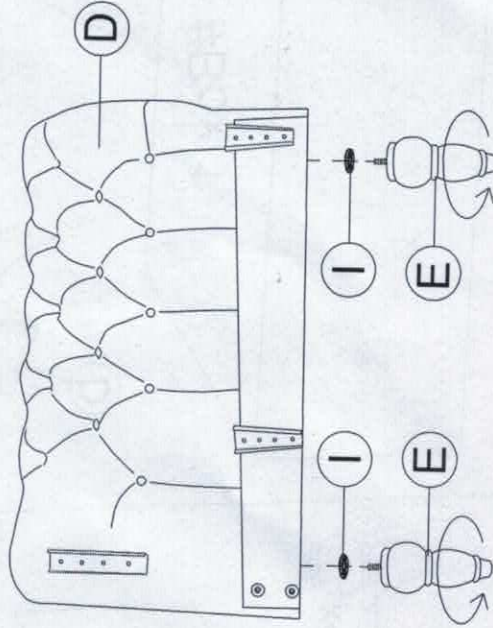
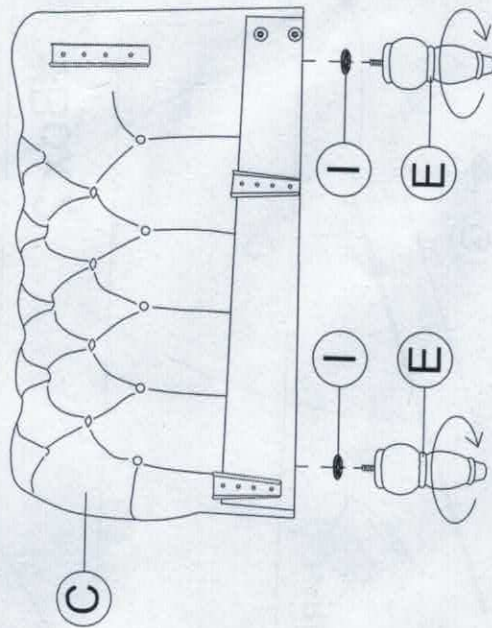
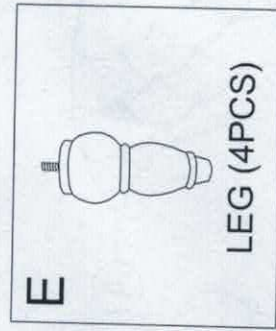
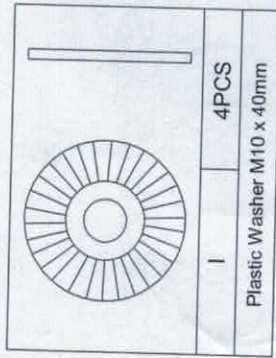

# ASSEMBLY INSTRUCTION

## STEP 2.

Slightly loosen the four bolts using Allen Key without removing the bolts completely from both Side Arms (C and D). Hook on Back Rail (F) hooks into loosened bolts, once placed tighten and secure all four bolts with Allen Key (H).

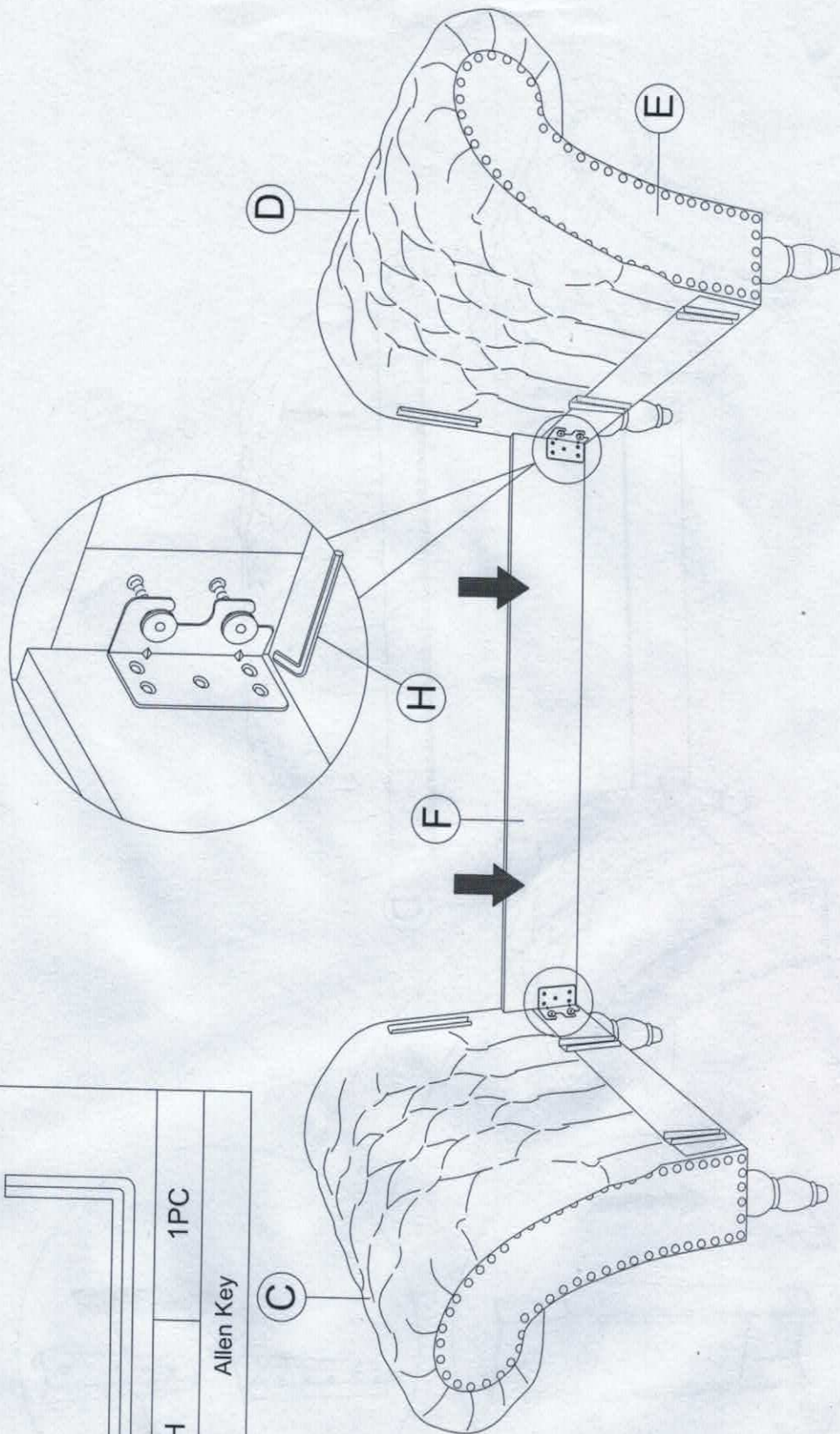
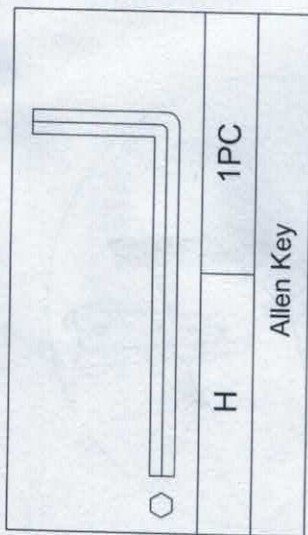

# ASSEMBLY INSTRUCTION

## STEP 3.

Hook on the Seat Frame (B) into Left Arm (C) and Right Arm (D) securely.

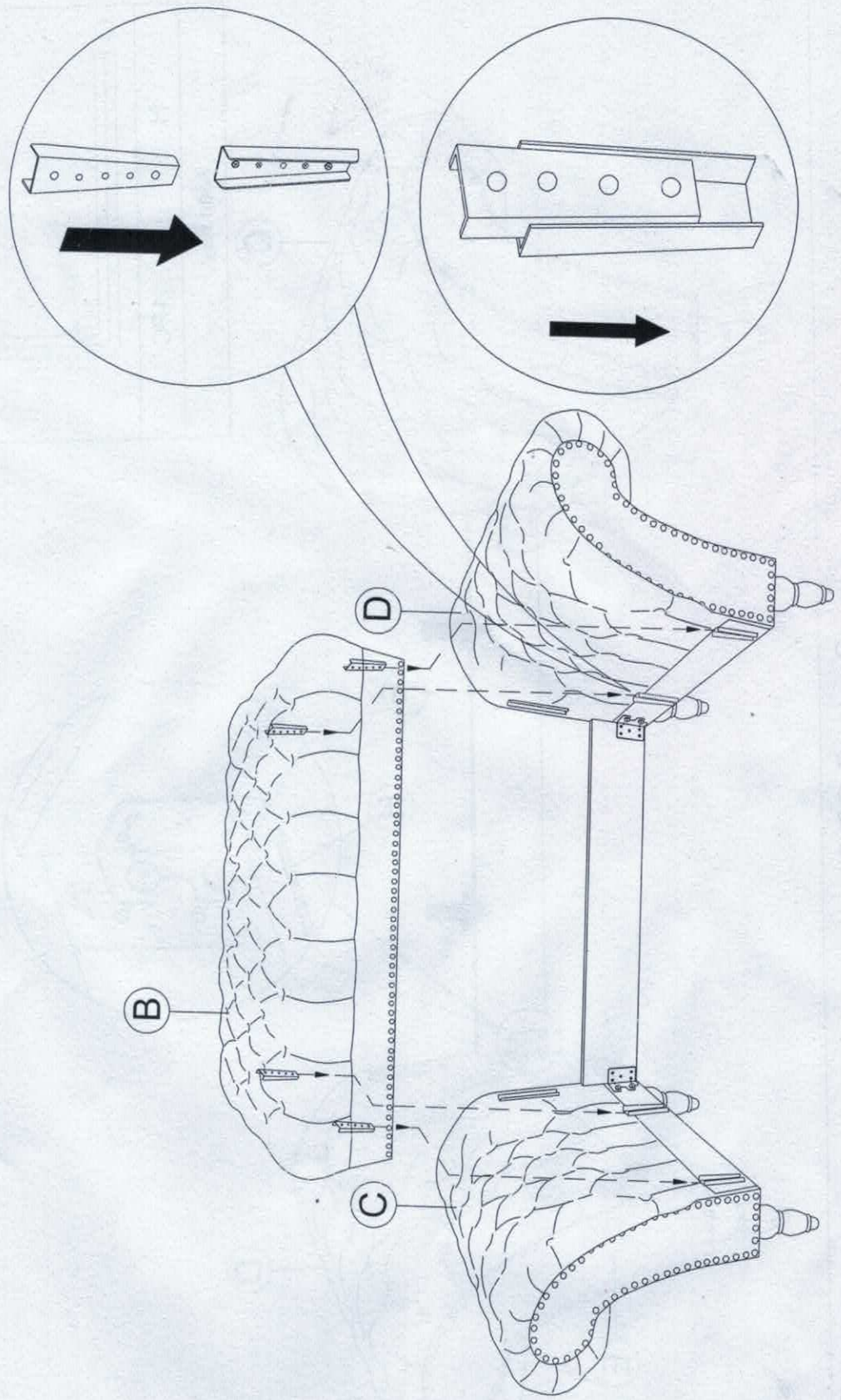

# ASSEMBLY INSTRUCTION

## STEP 4.

Hook on the Back Rest (A) into Left Arm (C) and Right Arm (D) securely.

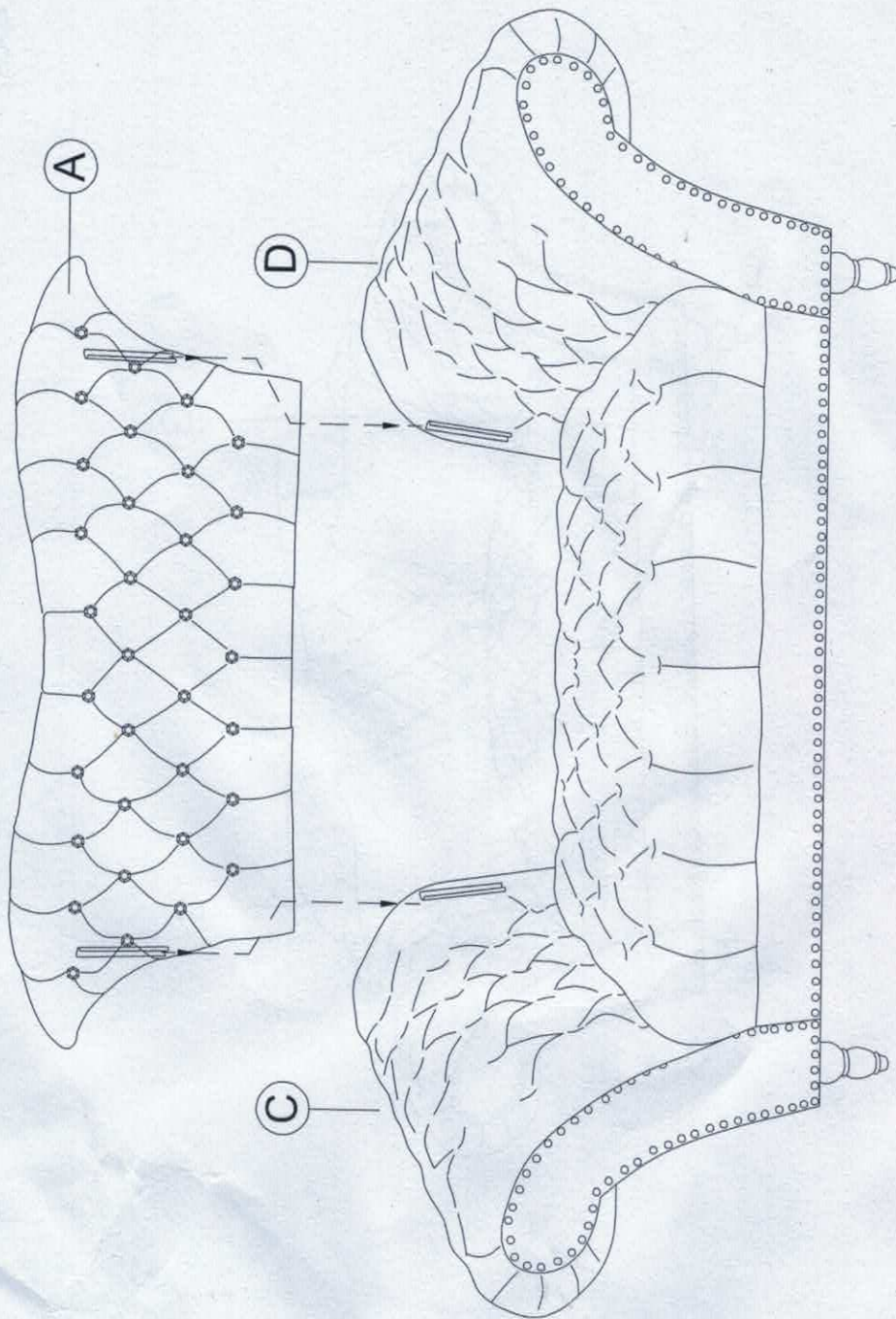

# ASSEMBLY INSTRUCTION

STEP 5.

Lay Pillows (G) (2pcs).

